

【11】證書號數：D229892

【45】公告日：中華民國 113 (2024) 年 02 月 01 日

【51】LOC. (13) Cl. : 07-01

設計

全42頁

【54】名稱：茶具組

【21】申請案號：112303911

【22】申請日：中華民國 112 (2023) 年 08 月 02 日

【72】設計人：陳俐穎 (TW)；姚宣如 (TW)；楊靖宇 (TW)；吳欣倫 (TW)

【71】申請人：東南科技大學

新北市深坑區北深路三段 152 號

【74】代理人：李世達

【56】參考文獻：

TW D224825

CN 301462262

CN 306466985

CN 307598228

審查人員：黃如瑛

設計說明

自代表圖所揭露之成組物品，包括有二第一茶杯、二第二茶杯、一第一茶壺、一第二茶壺、二茶壺蓋以及一扣具。如茶具組收納狀態圖可知，收納後之整體外觀線條流暢圓融，具有別緻之意境設計，供使用者於視覺上的新享受。

本創作茶具組自疊放參考圖可知，將第一茶杯以及第二茶杯置放於茶壺內部中；茶壺蓋置放於茶壺上；兩茶壺頂部相互凹凸疊合，形成如太極圖中兩極嵌合；將扣具嵌合於兩相互疊合茶壺的兩側。經由上述收納方便攜帶，且本創作外型整體線條宛如一體成型結構，其曲線、弧線之柔順線條構成，將柔順線條構成外形中，仍能涵蓋有對稱之工整構形。

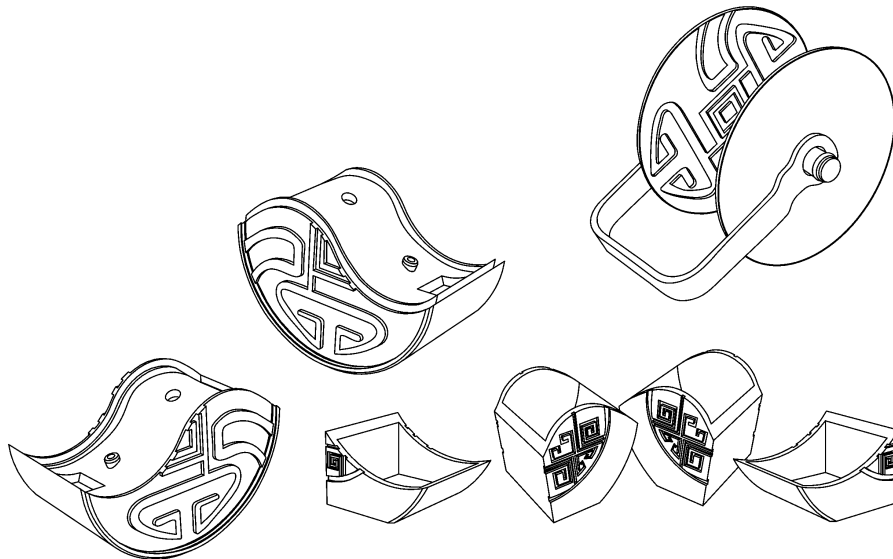

立體圖(代表圖)

(2)

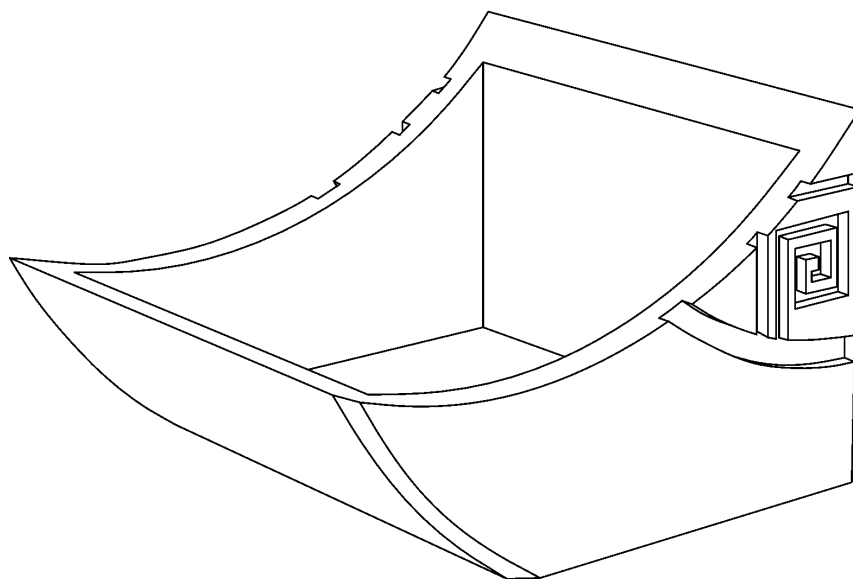

第一茶杯之立體圖

(3)

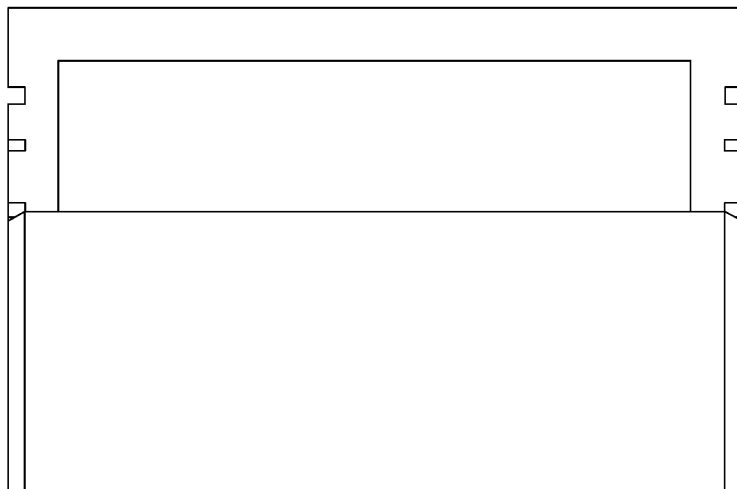

第一茶杯之前視圖

(4)



第一茶杯之後視圖

(5)

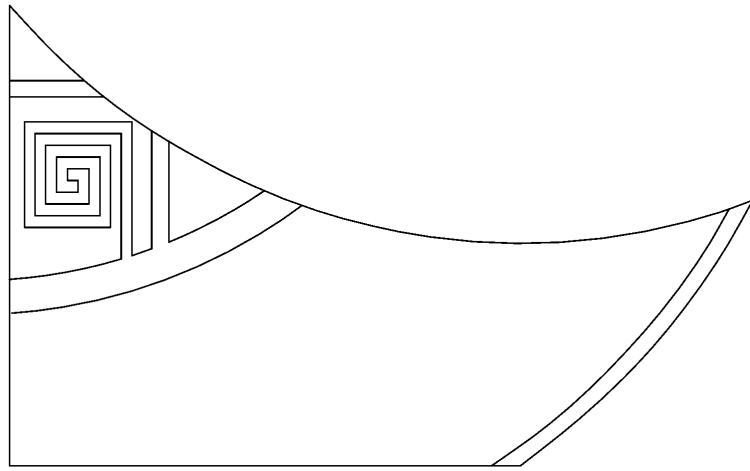

第一茶杯之左側視圖

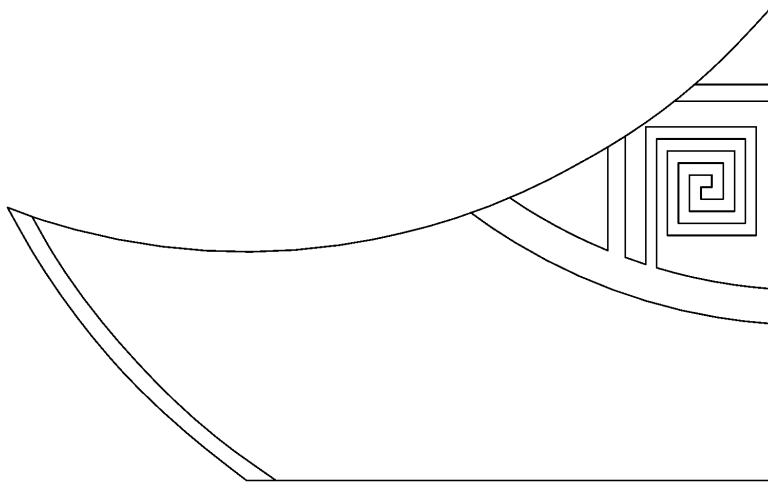

第一茶杯之右側視圖

(6)

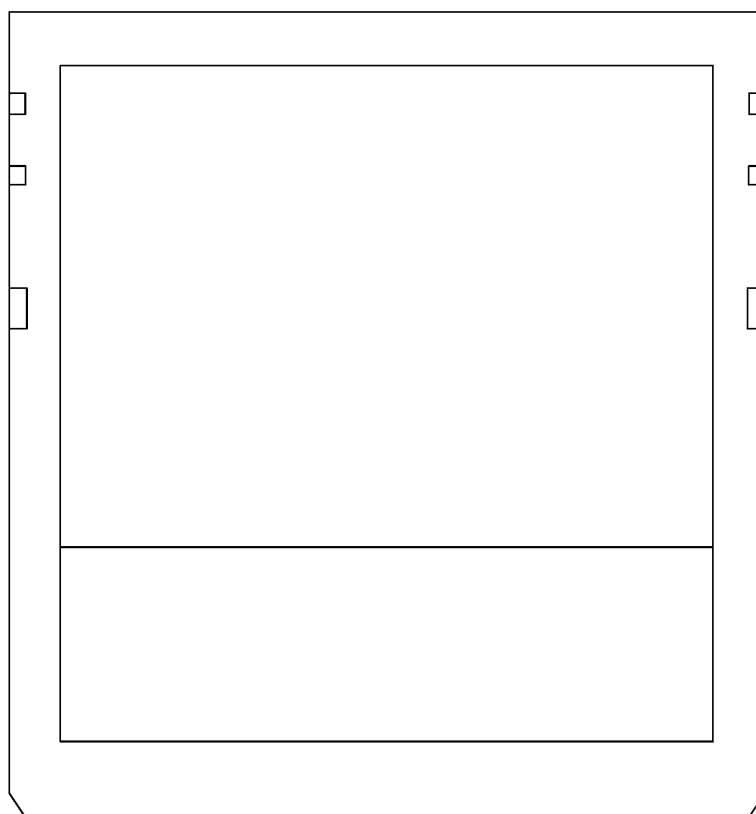

第一茶杯之俯視圖

(7)

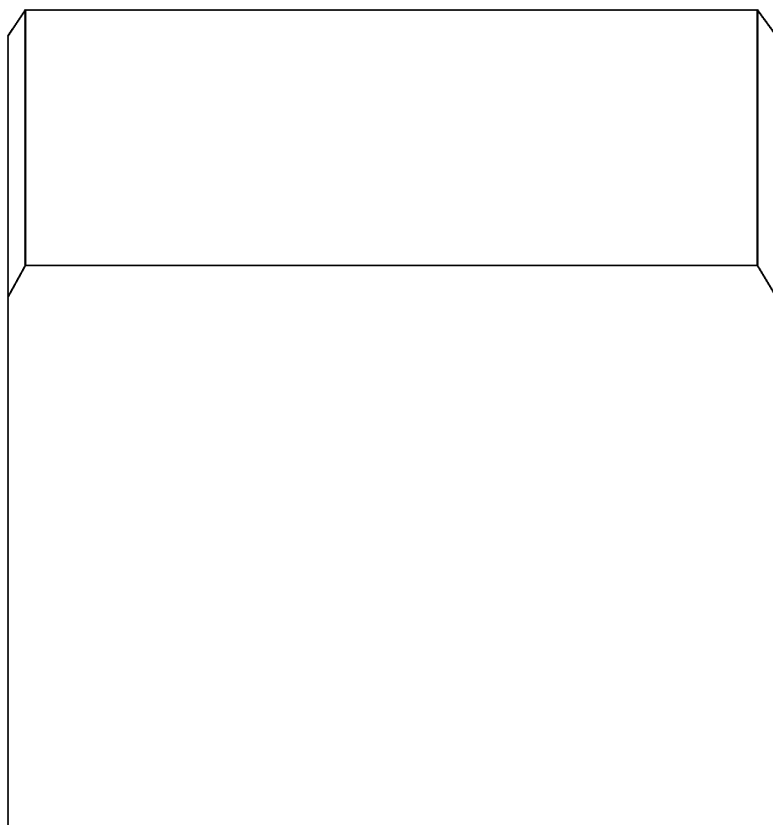

第一茶杯之仰視圖

(8)

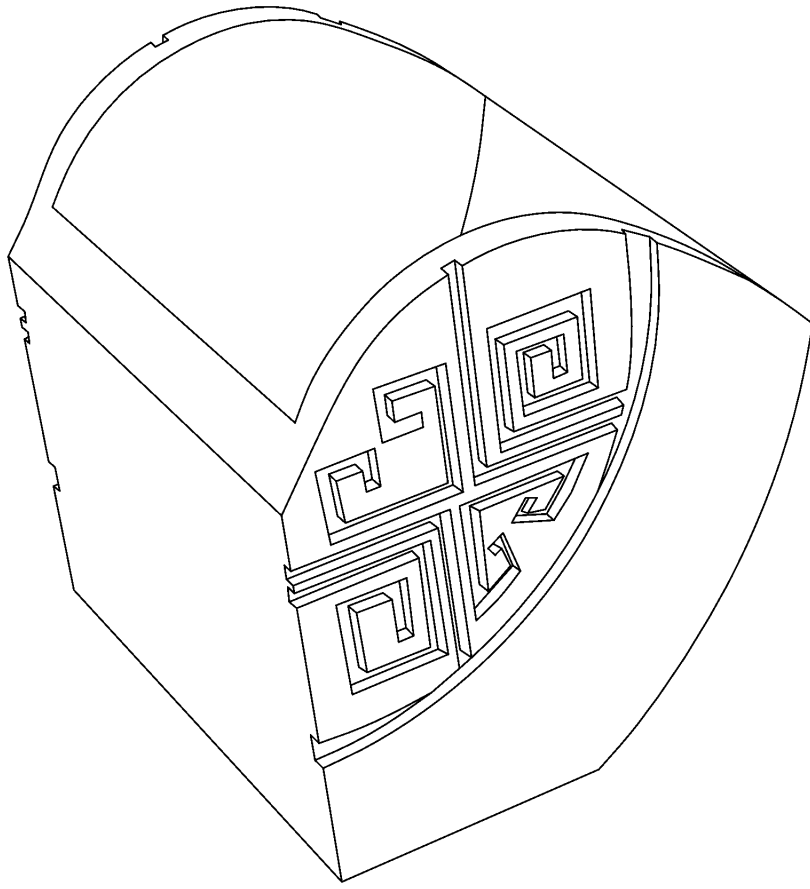

第二茶杯之立體圖



(9)

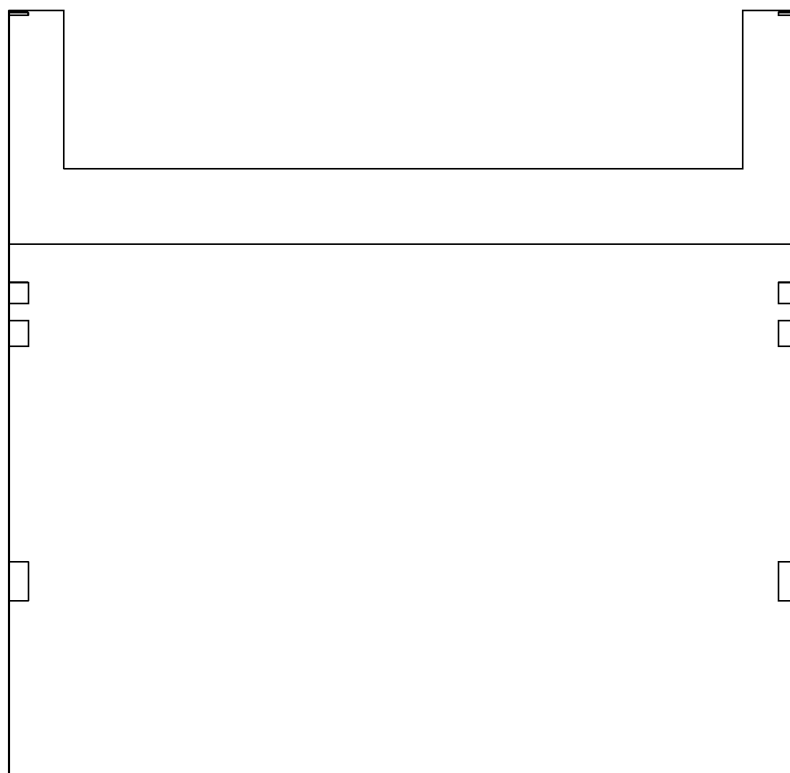

第二茶杯之前視圖

(10)

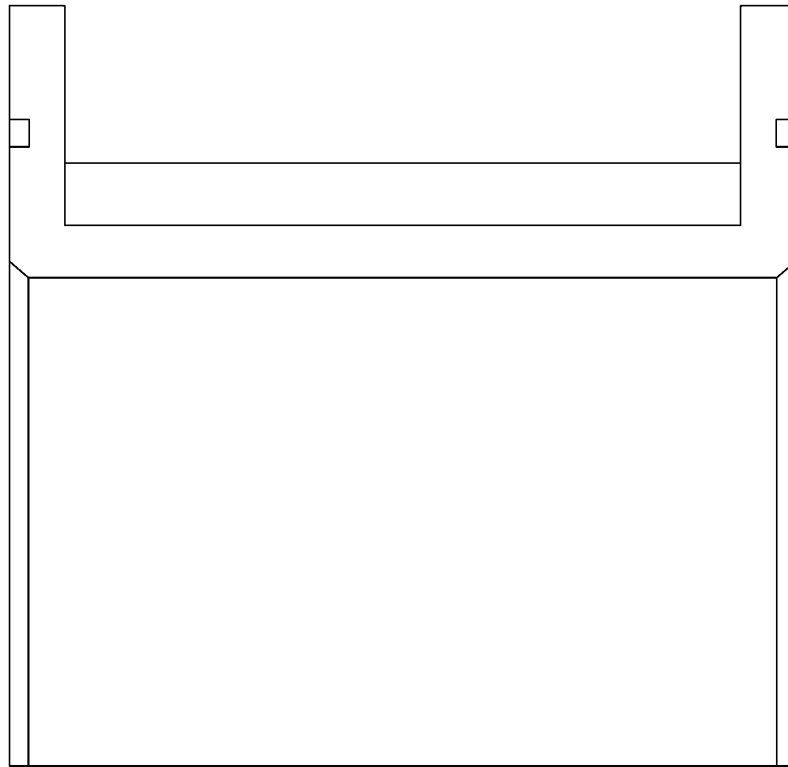

第二茶杯之後視圖

(11)

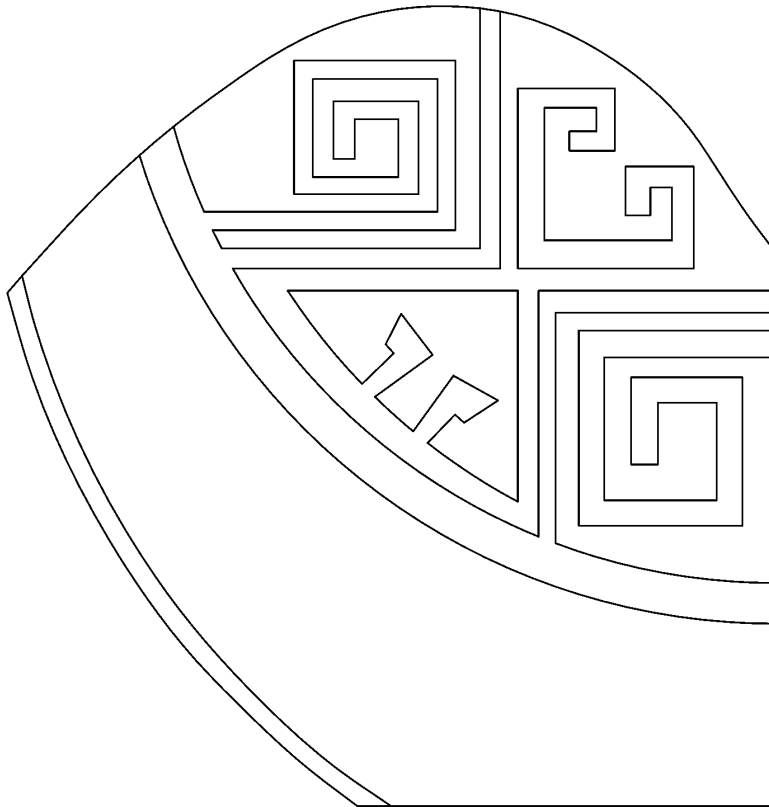

第二茶杯之左側視圖

(12)

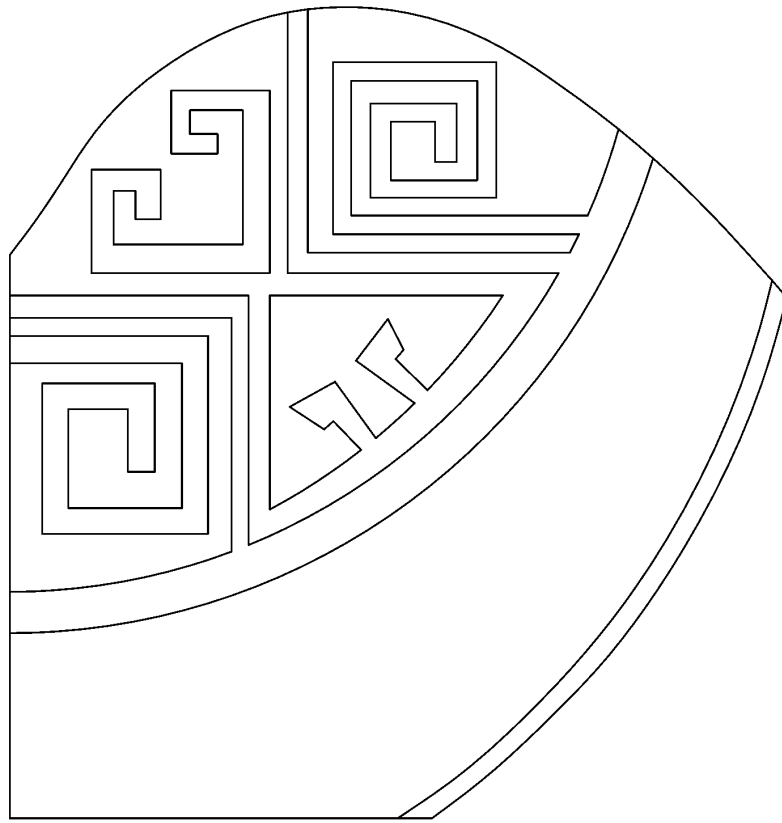

第二茶杯之右側視圖

(13)

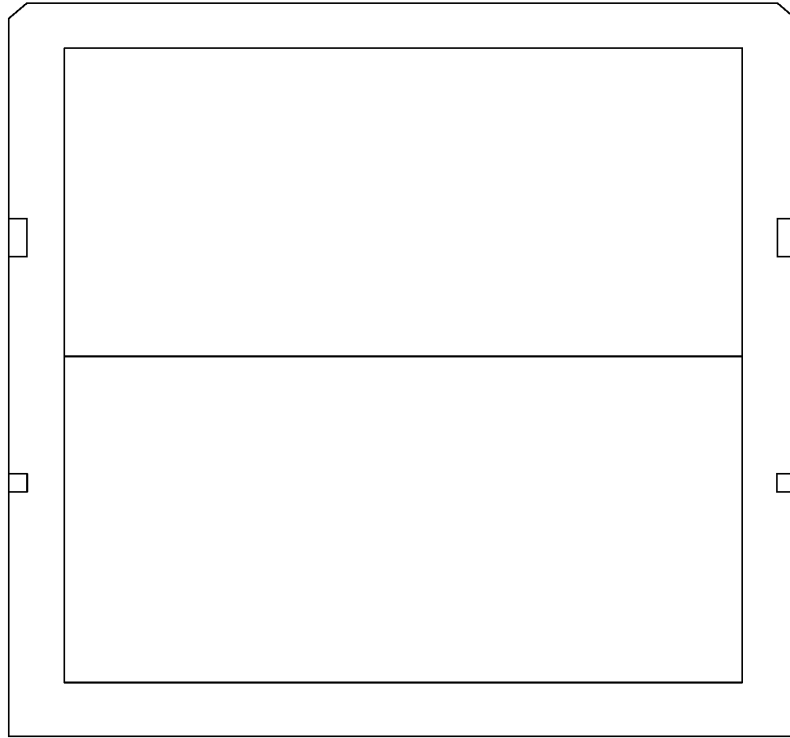

第二茶杯之俯視圖

(14)



第二茶杯之仰視圖

(15)

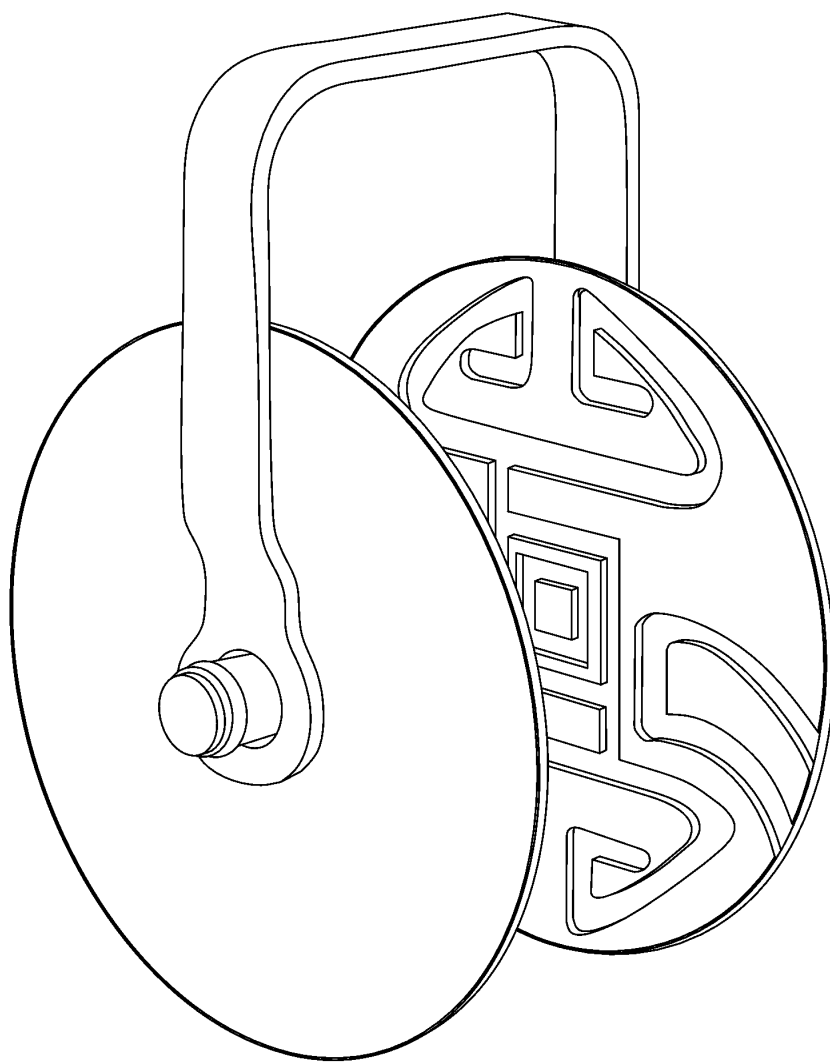

扣具之立體圖

(16)

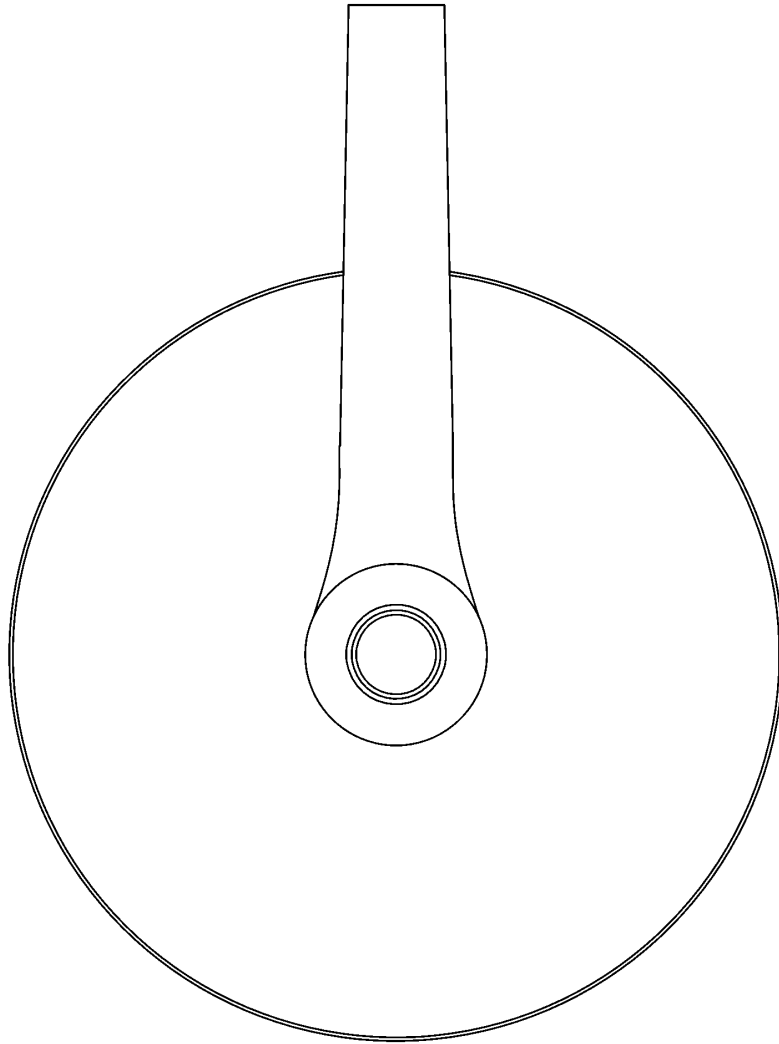

扣具之前視圖



(17)

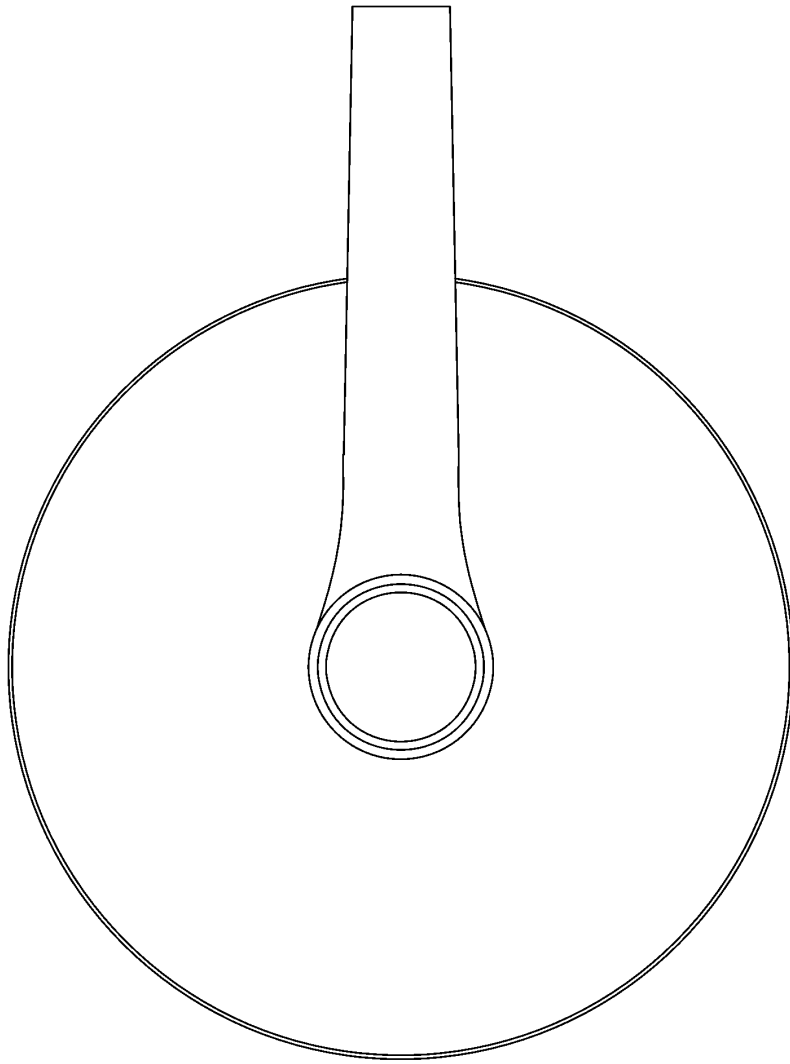

扣具之後視圖

(18)

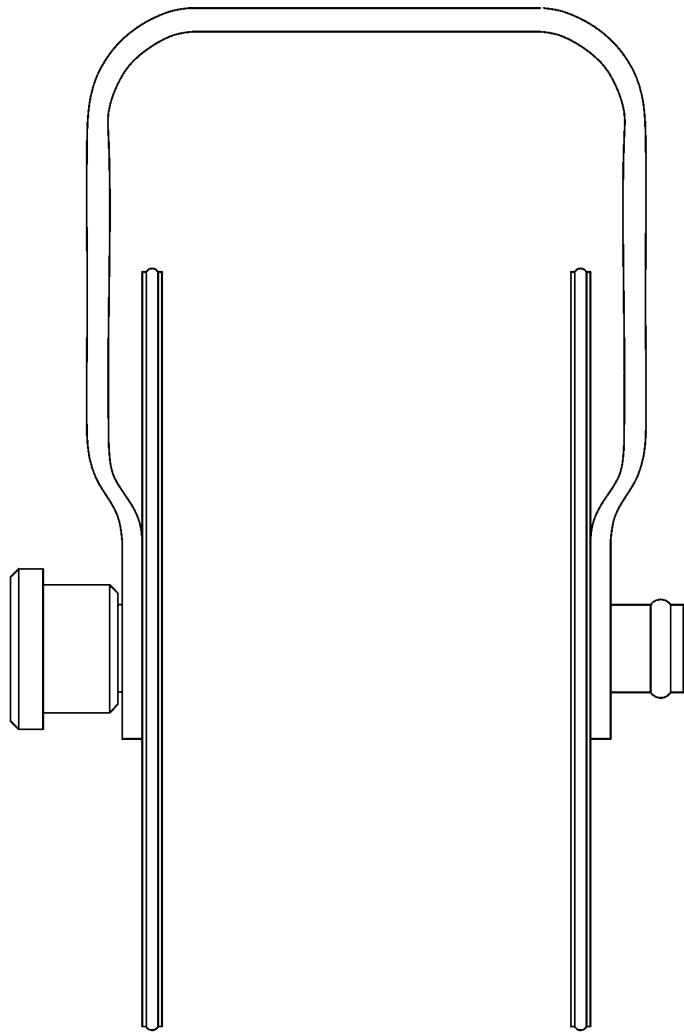

扣具之左側視圖

(19)

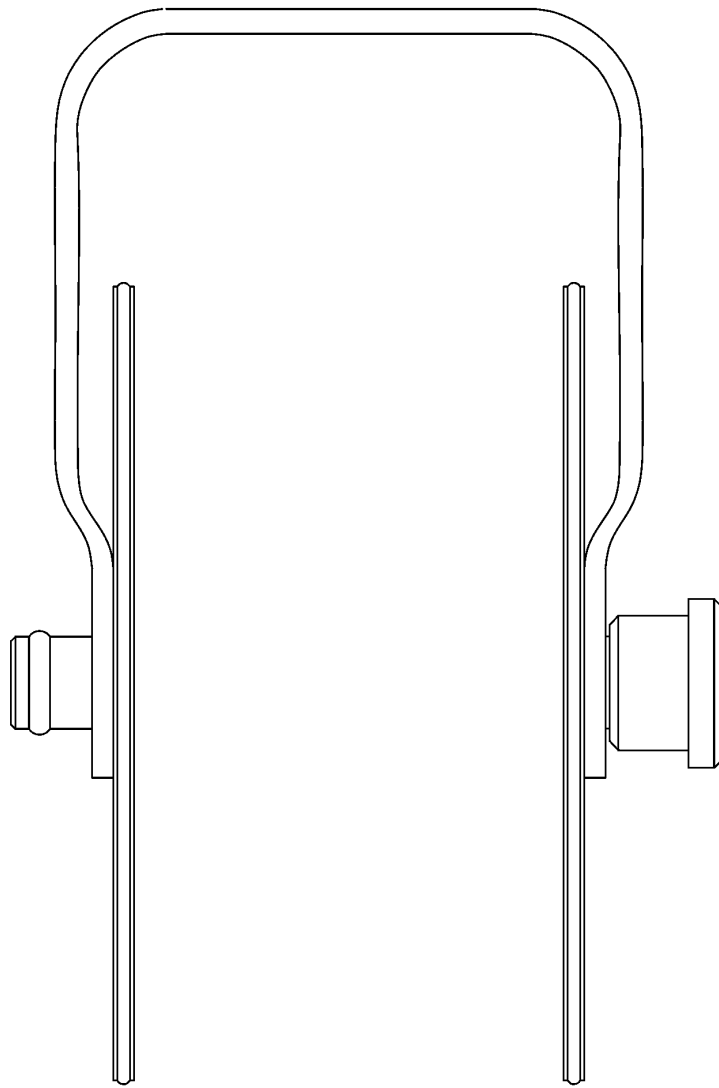

扣具之右側視圖

(20)

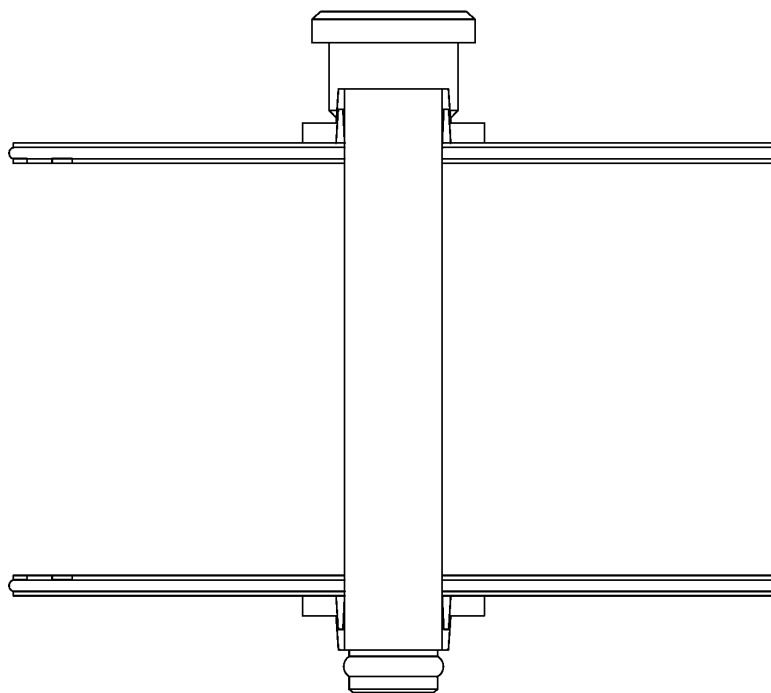

扣具之俯視圖

(21)

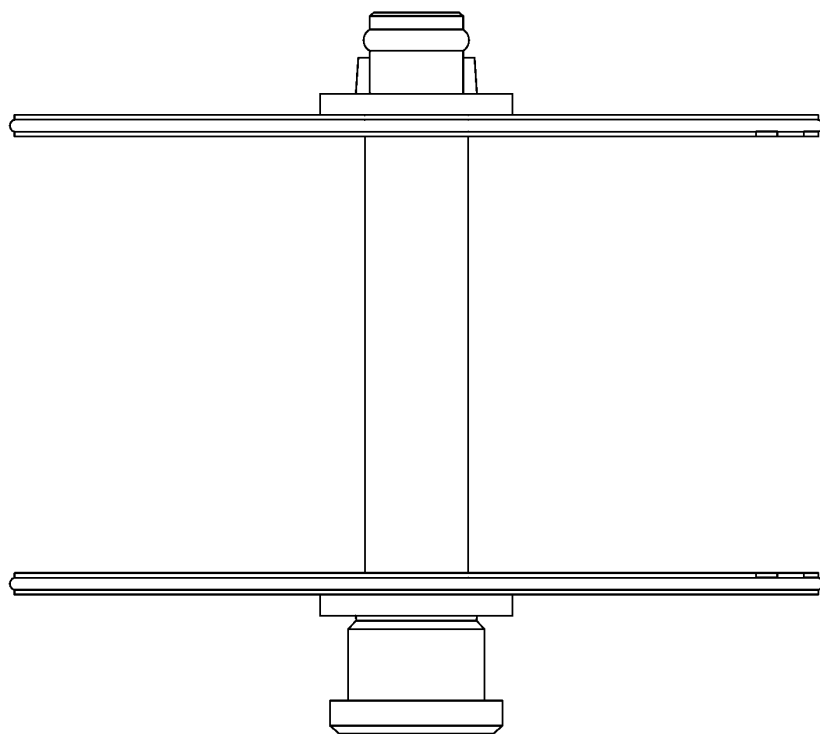

扣具之仰視圖

(22)

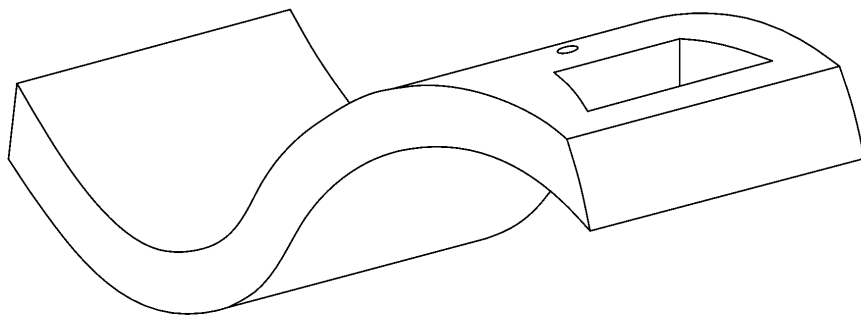

茶壺蓋之立體圖

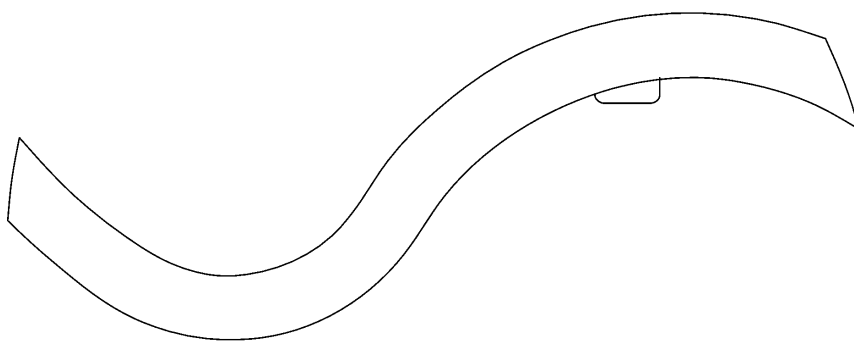

茶壺蓋之前視圖

(23)

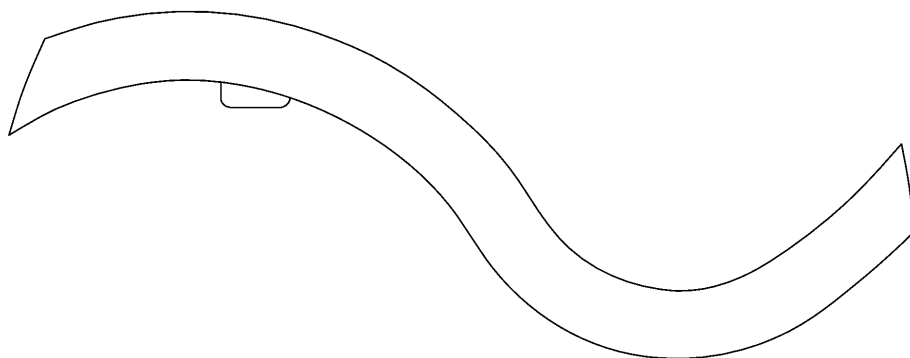

茶壺蓋之後視圖

(24)

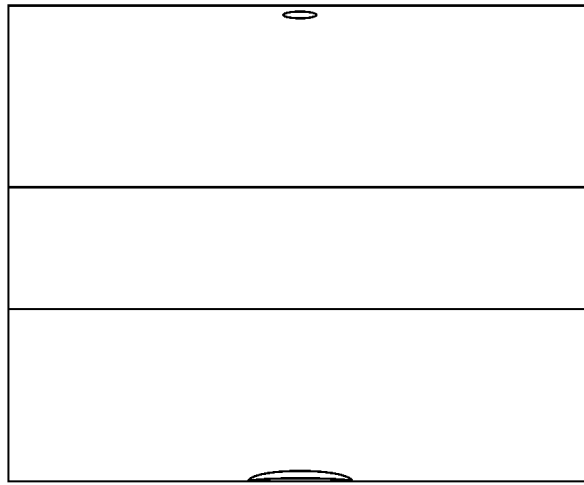

茶壺蓋之左側視圖



(25)

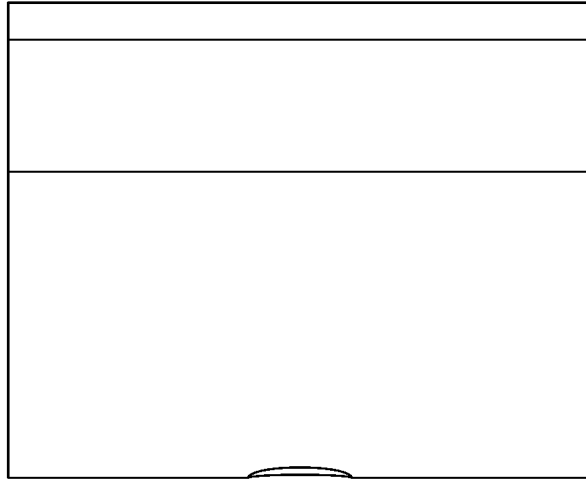

茶壺蓋之右側視圖

(26)



茶壺蓋之俯視圖

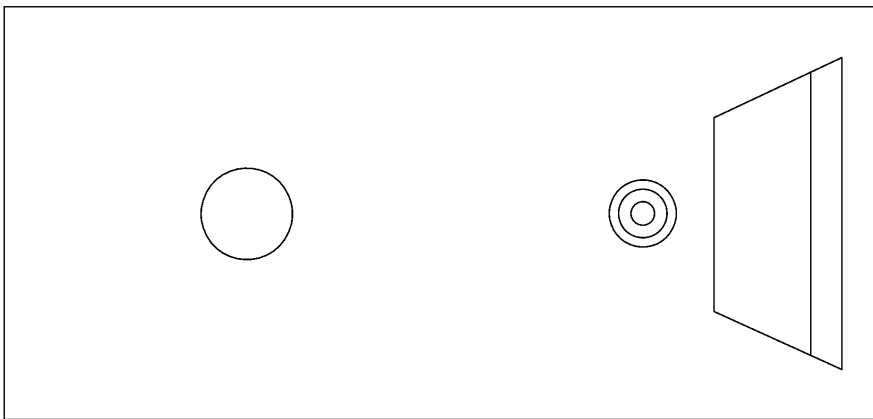

茶壺蓋之仰視圖

(27)

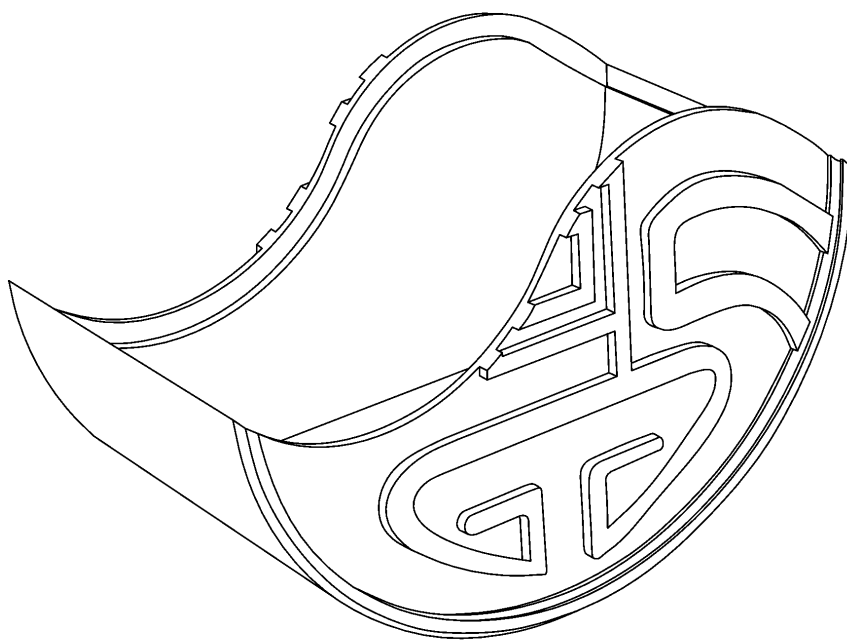

第一茶壺之立體圖

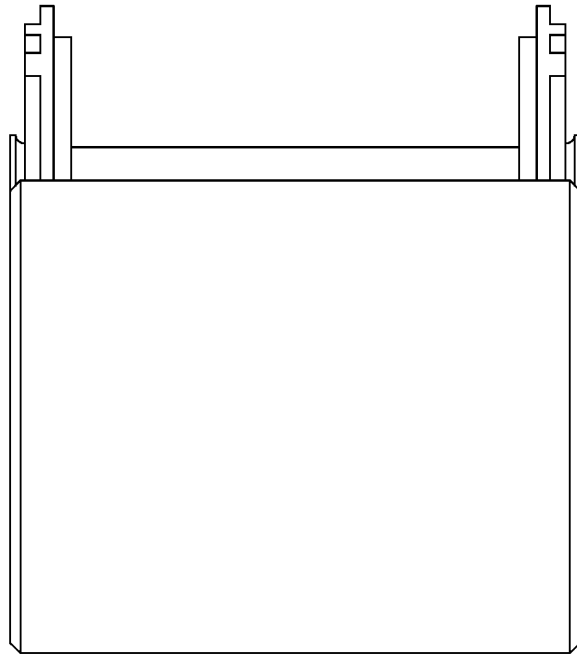

第一茶壺之前視圖

(29)

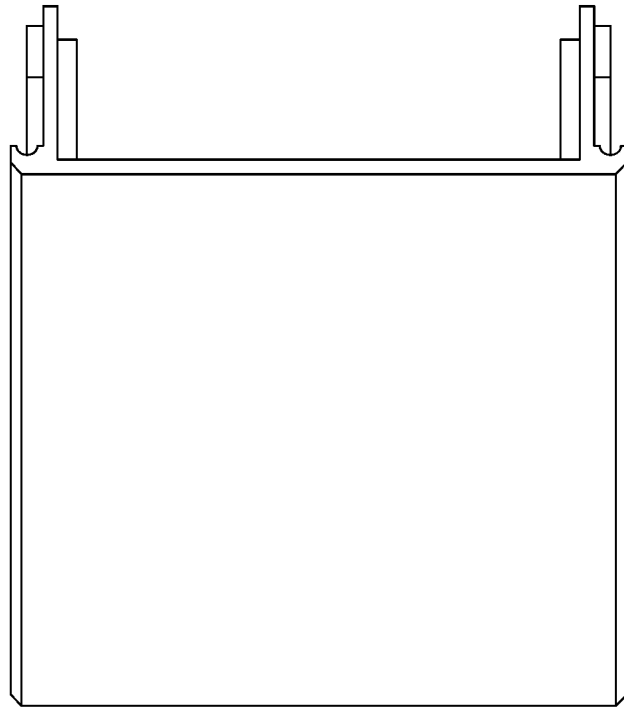

第一茶壺之後視圖

(30)

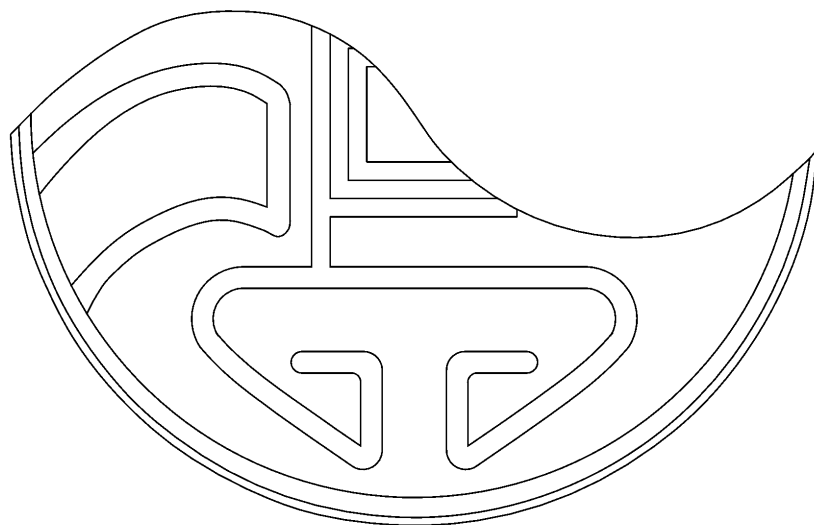

第一茶壺之左側視圖

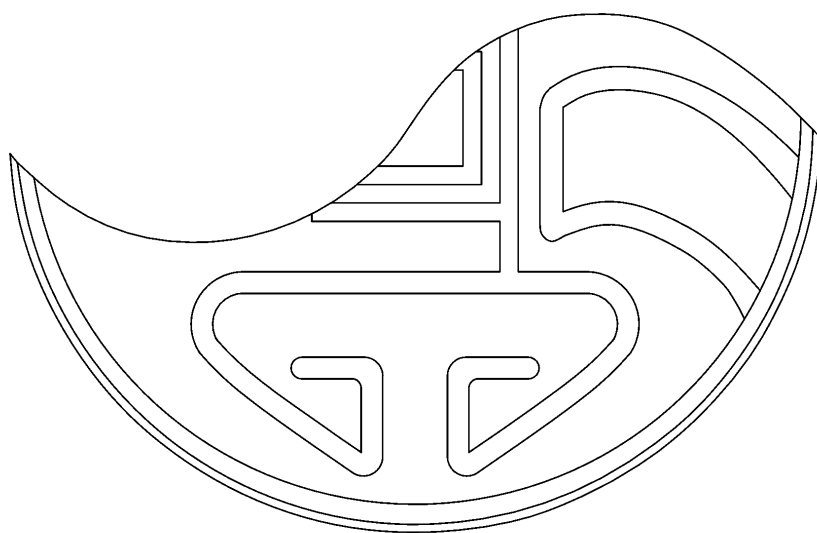

第一茶壺之右側視圖

(31)

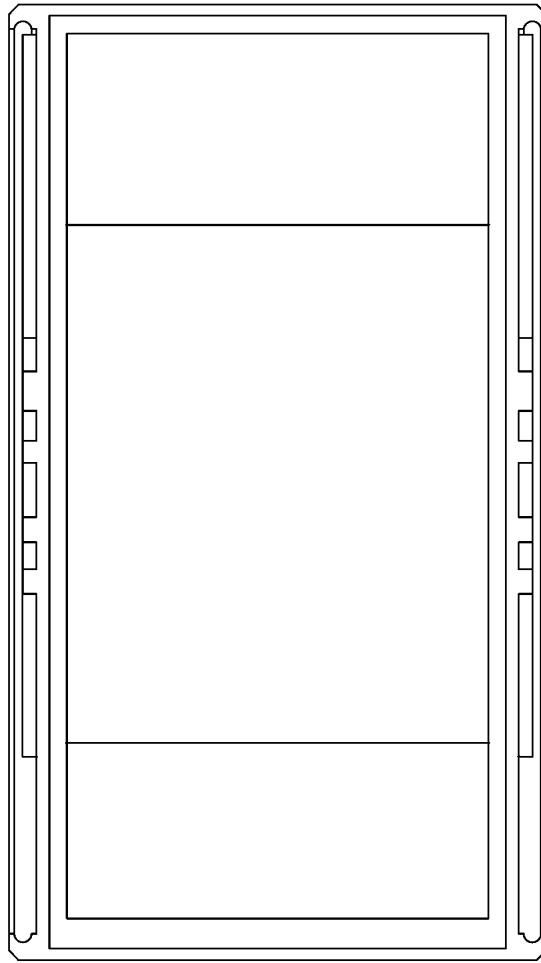

第一茶壺之俯視圖

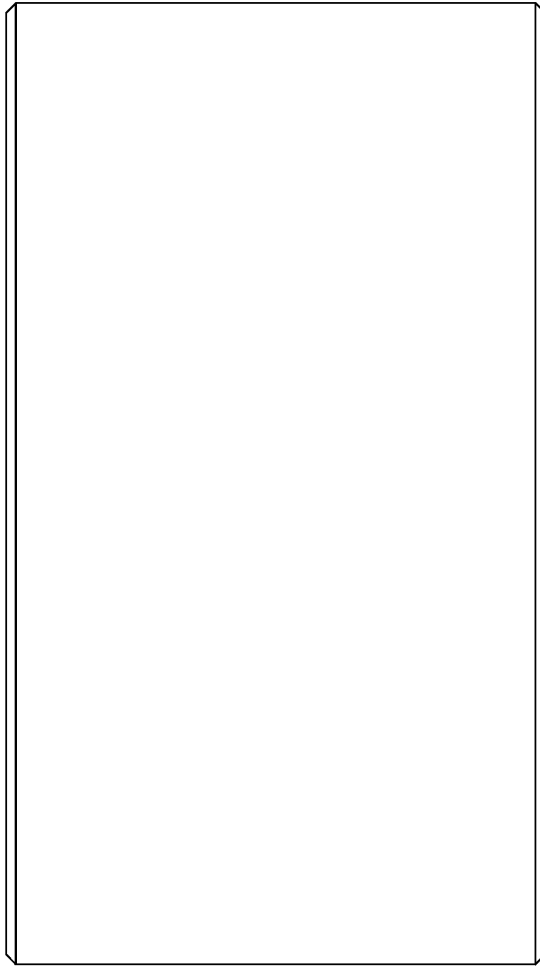

第一茶壺之仰視圖



(33)

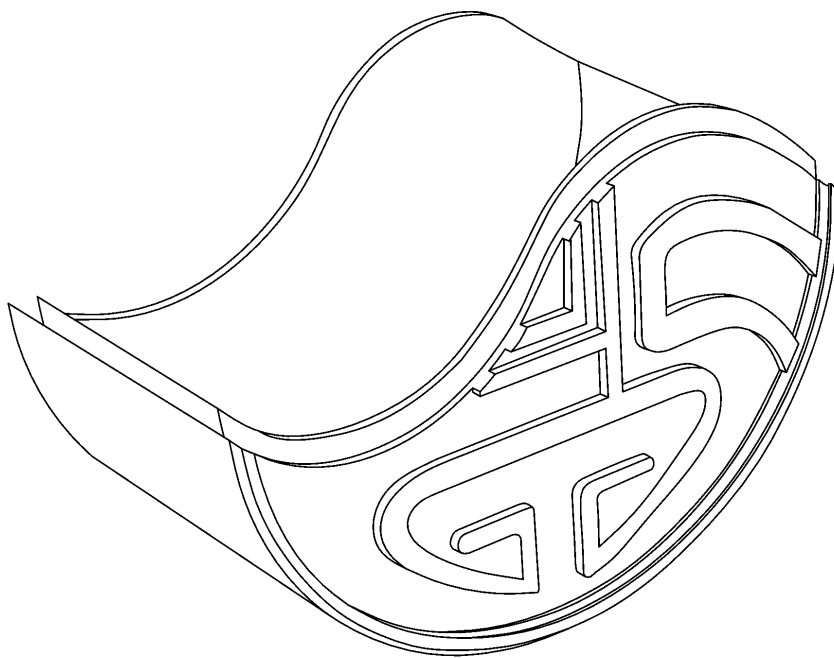

第二茶壺之立體圖

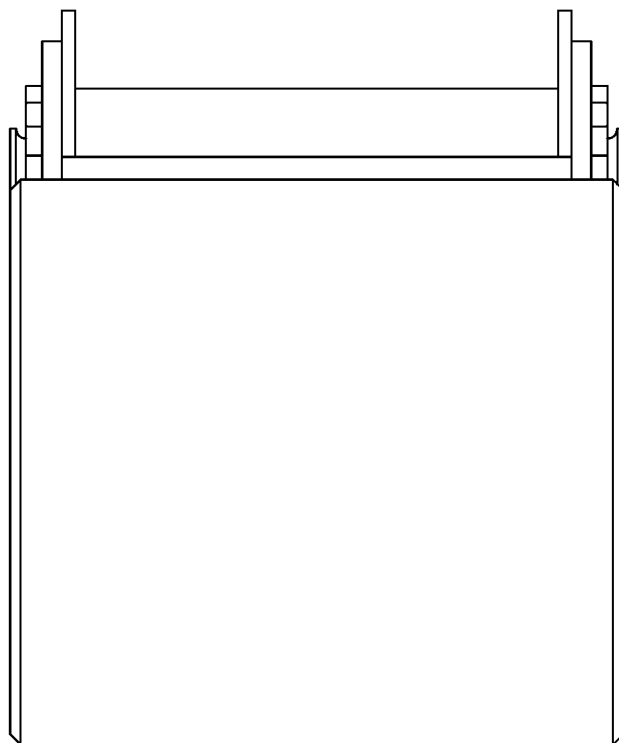

第二茶壺之前視圖

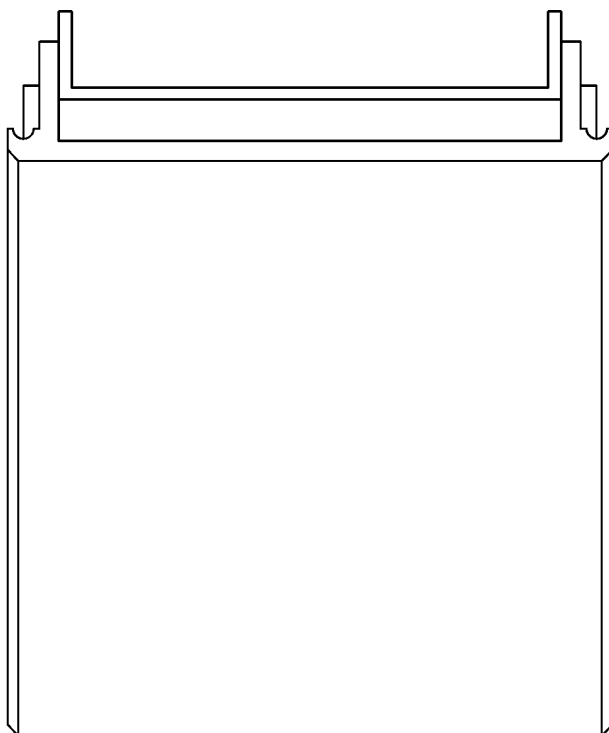

第二茶壺之後視圖

(36)

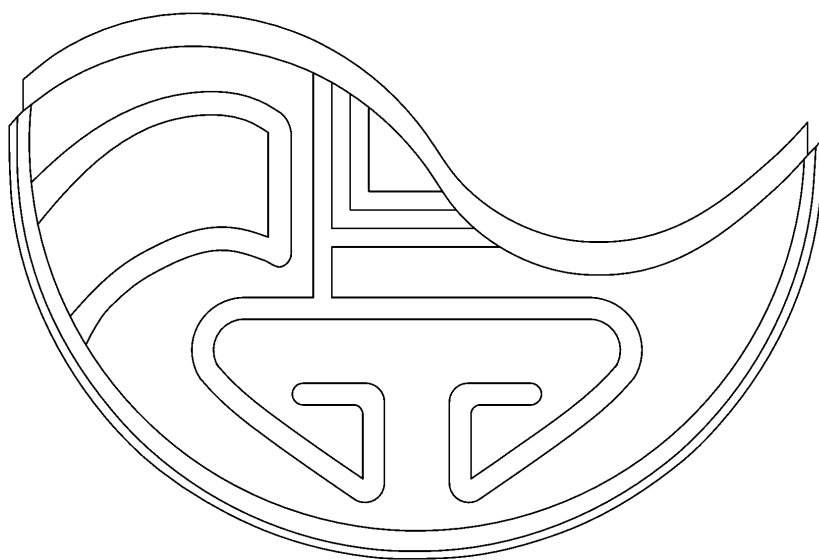

第二茶壺之左側視圖

(37)

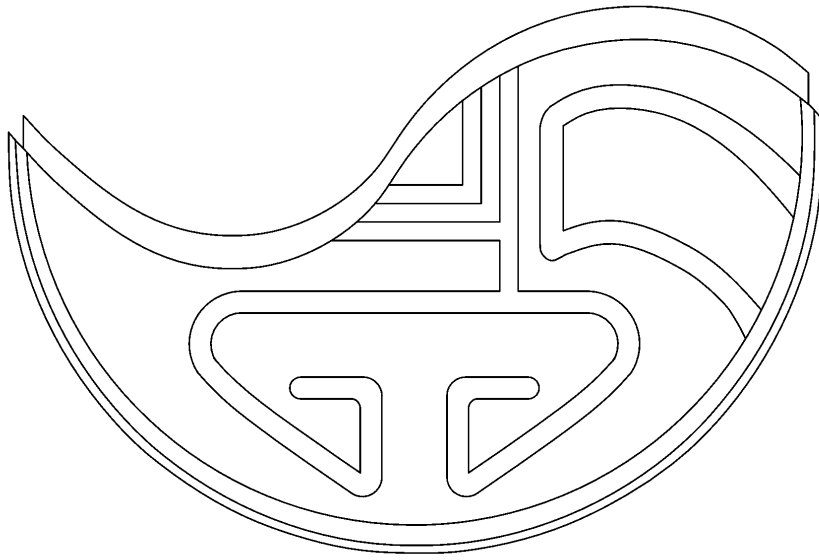

第二茶壺之右側視圖

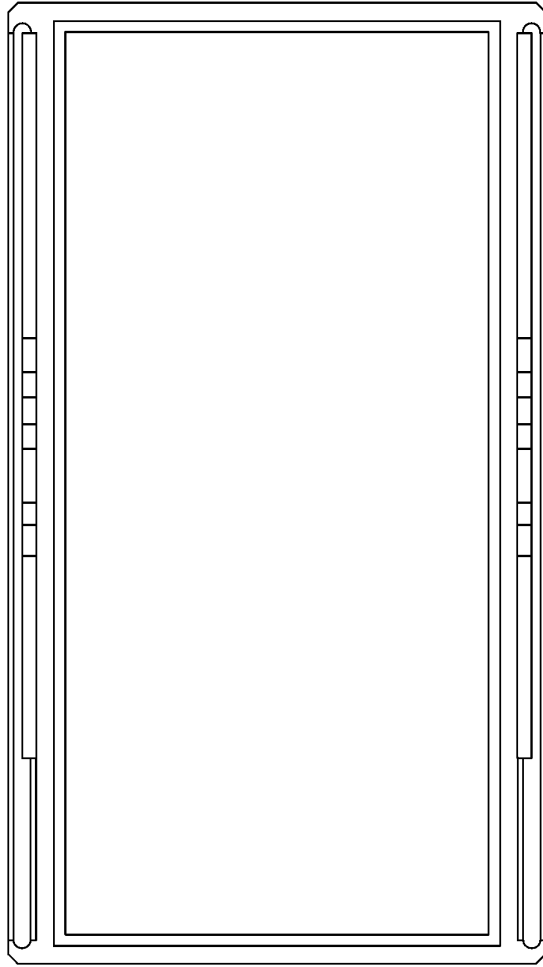

第二茶壺之俯視圖

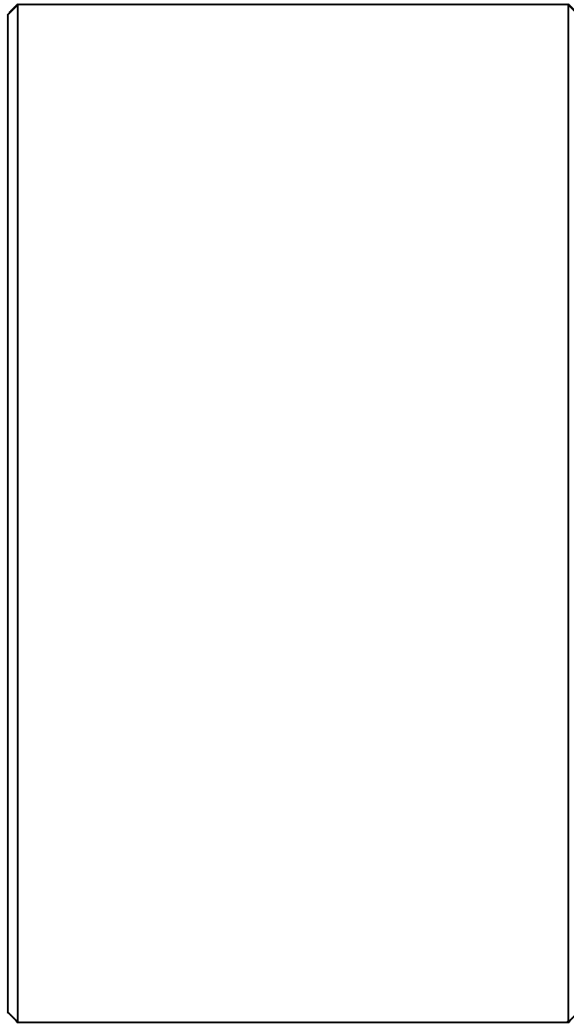

第二茶壺之仰視圖

(40)

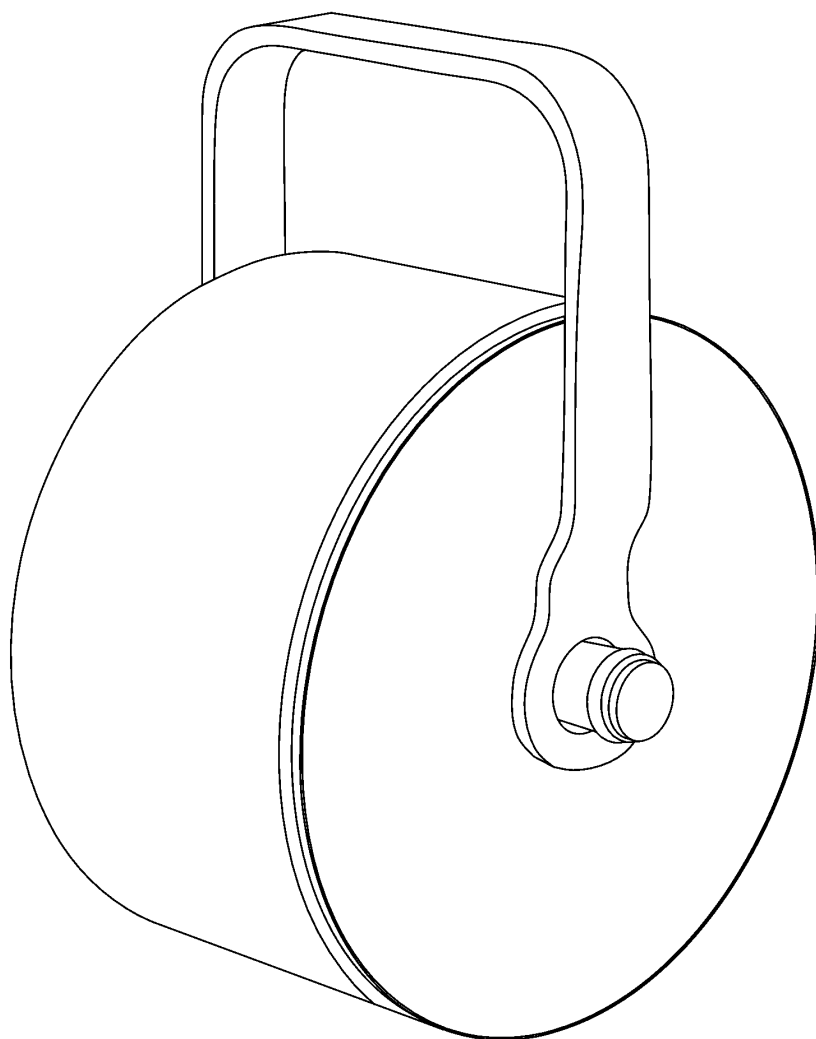

茶具組收納狀態參考圖



(41)

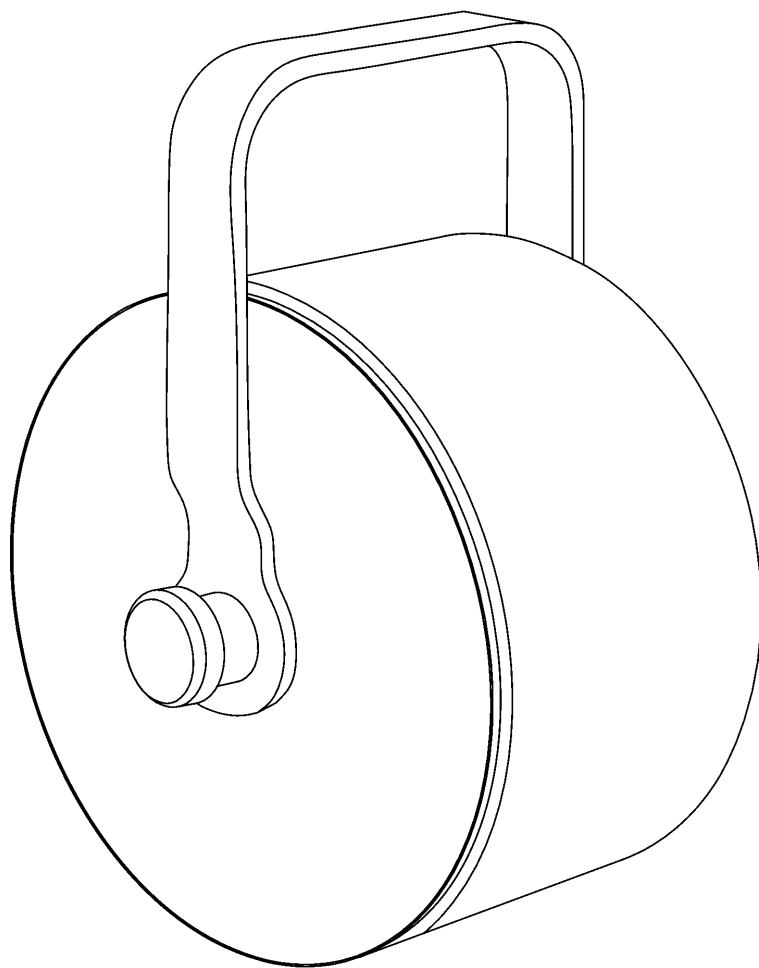

另一視角之茶具組收納狀態參考圖

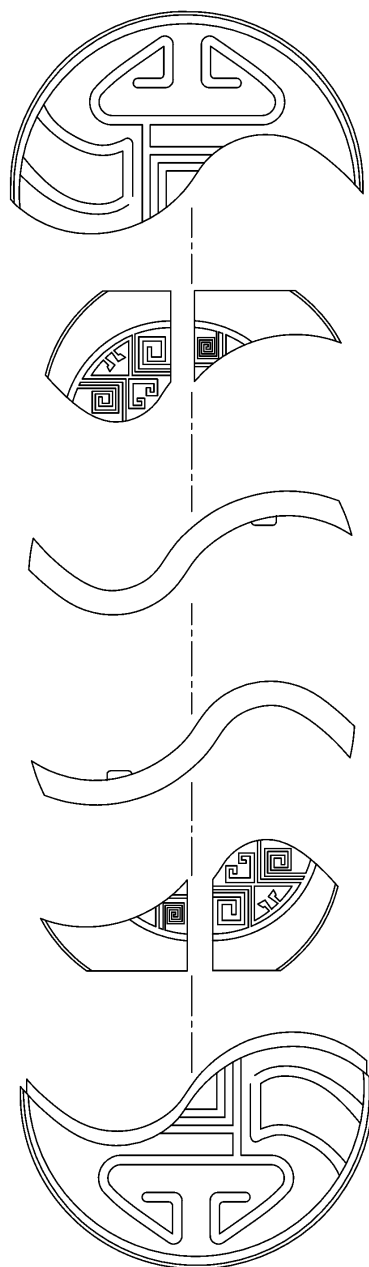

茶壺與茶杯疊放參考圖